Stream: Internet Engineering Task Force (IETF)
RFC: [9433](#)
Category: Informational
Published: July 2023
ISSN: 2070-1721
Authors: S. Matsushima, Ed. C. Filsfil M. Kohno
SoftBank Cisco Systems, Inc. Cisco Systems, Inc.
P. Camarillo, Ed. D. Voyer
Cisco Systems, Inc. Bell Canada

RFC 9433

Segment Routing over IPv6 for the Mobile User Plane

Abstract

This document discusses the applicability of Segment Routing over IPv6 (SRv6) to the user plane of mobile networks. The network programming nature of SRv6 accomplishes mobile user-plane functions in a simple manner. The statelessness of SRv6 and its ability to control both service layer path and underlying transport can be beneficial to the mobile user plane, providing flexibility, end-to-end network slicing, and Service Level Agreement (SLA) control for various applications.

This document discusses how SRv6 could be used as the user plane of mobile networks. This document also specifies the SRv6 Endpoint Behaviors required for mobility use cases.

Status of This Memo

This document is not an Internet Standards Track specification; it is published for informational purposes.

This document is a product of the Internet Engineering Task Force (IETF). It represents the consensus of the IETF community. It has received public review and has been approved for publication by the Internet Engineering Steering Group (IESG). Not all documents approved by the IESG are candidates for any level of Internet Standard; see Section 2 of RFC 7841.

Information about the current status of this document, any errata, and how to provide feedback on it may be obtained at <https://www.rfc-editor.org/info/rfc9433>.

Copyright Notice

Copyright (c) 2023 IETF Trust and the persons identified as the document authors. All rights reserved.

This document is subject to BCP 78 and the IETF Trust's Legal Provisions Relating to IETF Documents (<https://trustee.ietf.org/license-info>) in effect on the date of publication of this document. Please review these documents carefully, as they describe your rights and restrictions with respect to this document. Code Components extracted from this document must include Revised BSD License text as described in Section 4.e of the Trust Legal Provisions and are provided without warranty as described in the Revised BSD License.

Table of Contents

1. Introduction
2. Conventions and Terminology
 - 2.1. Terminology
 - 2.2. Conventions
 - 2.3. Predefined SRv6 Endpoint Behaviors
3. Motivation
4. 3GPP Reference Architecture
5. User-Plane Modes
 - 5.1. Traditional Mode
 - 5.1.1. Packet Flow - Uplink
 - 5.1.2. Packet Flow - Downlink
 - 5.2. Enhanced Mode
 - 5.2.1. Packet Flow - Uplink
 - 5.2.2. Packet Flow - Downlink
 - 5.2.3. Scalability
 - 5.3. Enhanced Mode with Unchanged gNB GTP-U Behavior
 - 5.3.1. Interworking with IPv6 GTP-U
 - 5.3.2. Interworking with IPv4 GTP-U
 - 5.3.3. Extensions to the Interworking Mechanisms
 - 5.4. SRv6 Drop-In Interworking
6. SRv6 Segment Endpoint Mobility Behaviors
 - 6.1. Args.Mob.Session
 - 6.2. End.MAP
 - 6.3. End.M.GTP6.D

- 6.4. End.M.GTP6.D.Di
- 6.5. End.M.GTP6.E
- 6.6. End.M.GTP4.E
- 6.7. H.M.GTP4.D
- 6.8. End.Limit
- 7. SRv6-Supported 3GPP PDU Session Types
- 8. Network Slicing Considerations
- 9. Control Plane Considerations
- 10. Security Considerations
- 11. IANA Considerations
- 12. References
 - 12.1. Normative References
 - 12.2. Informative References
- Acknowledgements
- Contributors
- Authors' Addresses

1. Introduction

In mobile networks, mobility systems provide connectivity over a wireless link to stationary and non-stationary nodes. The user plane establishes a tunnel between the mobile node and its anchor node over IP-based backhaul and core networks.

This document specifies the applicability of SRv6 [RFC8754] [RFC8986] to mobile networks.

Segment Routing (SR) [RFC8402] is a source-routing architecture: a node steers a packet through an ordered list of instructions called "segments". A segment can represent any instruction, topological or service based.

SRv6 applied to mobile networks enables a mobile architecture based on source routing, where operators can explicitly indicate a route for the packets to and from the mobile node. The SRv6 Endpoint nodes serve as mobile user-plane anchors.

2. Conventions and Terminology

The key words "MUST", "MUST NOT", "REQUIRED", "SHALL", "SHALL NOT", "SHOULD", "SHOULD NOT", "RECOMMENDED", "NOT RECOMMENDED", "MAY", and "OPTIONAL" in this document are to be interpreted as described in BCP 14 [RFC2119] [RFC8174] when, and only when, they appear in all capitals, as shown here.

2.1. Terminology

CNF: Cloud-native Network Function

NFV: Network Function Virtualization

PDU: Packet Data Unit

PDU Session: Context of a UE connected to a mobile network

UE: User Equipment

gNB: gNodeB [TS.23501]

UPF: User Plane Function

VNF: Virtual Network Function

DN: Data Network

Uplink: from the UE towards the DN

Downlink: from the DN towards the UE

The following terms used within this document are defined in [RFC8402]: Segment Routing, SR domain, Segment ID (SID), SRv6, SRv6 SID, Active Segment, SR Policy, and Binding SID (BSID).

The following terms used within this document are defined in [RFC8754]: Segment Routing Header (SRH) and Reduced SRH.

The following terms used within this document are defined in [RFC8986]: NH (next header), SL (the Segments Left field of the SRH), FIB (Forwarding Information Base), SA (Source Address), DA (Destination Address), and SRv6 Endpoint Behavior.

2.2. Conventions

An SR Policy is resolved to a SID list. A SID list is represented as <S1, S2, S3> where S1 is the first SID to visit, S2 is the second SID to visit, and S3 is the last SID to visit along the SR path.

(SA,DA) (S3, S2, S1; SL) represents an IPv6 packet where:

- Source Address is SA, Destination Address is DA, and next header is SRH

- SRH with SID list <S1, S2, S3> with Segments Left = SL

Note the difference between the <> and () symbols. <S1, S2, S3> represents a SID list where S1 is the first SID and S3 is the last SID to traverse. (S3, S2, S1; SL) represents the same SID list but encoded in the SRH format where the rightmost SID in the SRH is the first SID and the leftmost SID in the SRH is the last SID. When referring to an SR Policy in a high-level use case, it is simpler to use the <S1, S2, S3> notation. When referring to an illustration of the detailed packet behavior, the (S3, S2, S1; SL) notation is more convenient.

- The payload of the packet is omitted.

(SA1,DA1) (SA2, DA2) represents an IPv6 packet where:

- Source Address is SA1, Destination Address is DA1, and next header is IP.
- Source Address is SA2, and Destination Address is DA2.

Throughout the document, the representation SRH[n] is used as a shorter representation of Segment List[n], as defined in [\[RFC8754\]](#).

This document uses the following conventions throughout the different examples:

- gNB::1 is an IPv6 address (SID) assigned to the gNB.
- U1::1 is an IPv6 address (SID) assigned to UPF1.
- U2::1 is an IPv6 address (SID) assigned to UPF2.
- U2:: is the Locator of UPF2.

2.3. Predefined SRv6 Endpoint Behaviors

The following SRv6 Endpoint Behaviors are used throughout this document. They are defined in [\[RFC8986\]](#).

- End.DT4: Decapsulation and Specific IPv4 Table Lookup
- End.DT6: Decapsulation and Specific IPv6 Table Lookup
- End.DT46: Decapsulation and Specific IP Table Lookup
- End.DX4: Decapsulation and IPv4 Cross-Connect
- End.DX6: Decapsulation and IPv6 Cross-Connect
- End.DX2: Decapsulation and L2 Cross-Connect
- End.T: Endpoint with specific IPv6 Table Lookup

This document defines new SRv6 Endpoint Behaviors in [Section 6](#).

3. Motivation

Mobile networks are becoming more challenging to operate. On one hand, traffic is constantly growing, and latency requirements are tighter; on the other hand, there are new use cases like distributed NFV Infrastructure that are also challenging network operations. On top of this, the number of devices connected is steadily growing, causing scalability problems in mobile entities as the state to maintain keeps increasing.

The current architecture of mobile networks does not take into account the underlying transport. The user plane is rigidly fragmented into radio access, core, and service networks that connected by tunneling according to user-plane roles such as access and anchor nodes. These factors have made it difficult for the operator to optimize and operate the data path.

In the meantime, applications have shifted to use IPv6, and network operators have started adopting IPv6 as their IP transport. SRv6, the IPv6 data plane instantiation of Segment Routing [RFC8402], integrates both the application data path and the underlying transport layer into a single protocol, allowing operators to optimize the network in a simplified manner and removing forwarding state from the network. It is also suitable for virtualized environments, like VNF/CNF-to-VNF/CNF networking. SRv6 has been deployed in dozens of networks [SRV6-DEPLOY-STAT].

SRv6 defines the network programming concept [RFC8986]. Applied to mobility, SRv6 can provide the user-plane behaviors needed for mobility management. SRv6 takes advantage of the underlying transport awareness and flexibility together with the ability to also include services to optimize the end-to-end mobile data plane.

The use cases for SRv6 mobility are discussed in [SRV6-MOB-USECASES], and the architectural benefits are discussed in [SRV6-MOB-ARCH-DISCUSS].

4. 3GPP Reference Architecture

This section presents the 3GPP reference architecture and possible deployment scenarios.

Figure 1 shows a reference diagram from the 5G packet core architecture [TS.23501].

The user plane described in this document does not depend on any specific architecture. The 5G packet core architecture as shown is based on the 3GPP standards.

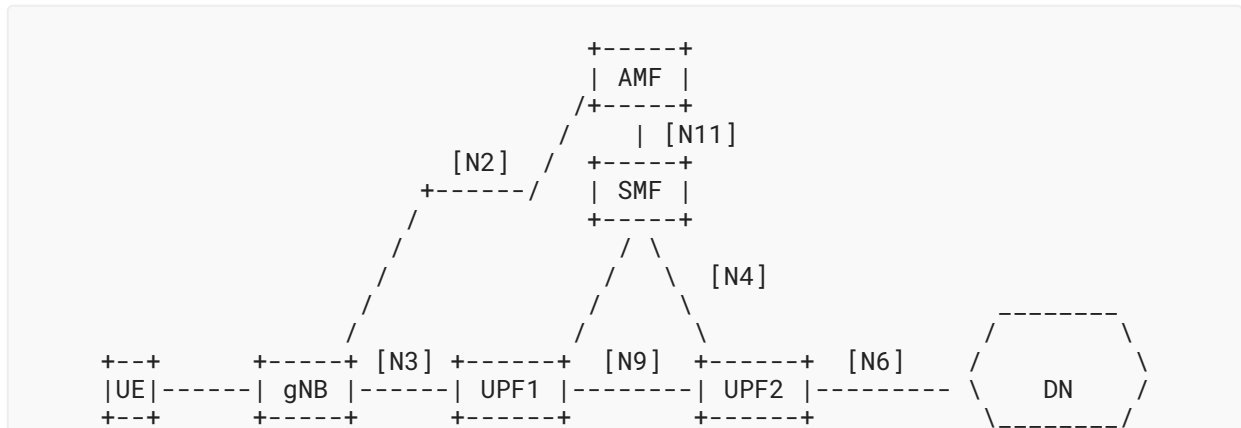

Figure 1: 3GPP 5G Reference Architecture

UE: User Equipment

gNB: gNodeB with N3 interface towards packet core (and N2 for control plane)

UPF1: UPF with Interfaces N3 and N9 (and N4 for control plane)

UPF2: UPF with Interfaces N9 and N6 (and N4 for control plane)

SMF: Session Management Function

AMF: Access and Mobility Management Function

DN: Data Network, e.g., operator services and Internet access

This reference diagram does not depict a UPF that is only connected to N9 interfaces, although the mechanisms defined in this document also work in such a case.

Each session from a UE gets assigned to a UPF. Sometimes multiple UPFs may be used, providing richer service functions. A UE gets its IPv4 address, or IPv6 prefix, from the DHCP block of its UPF. The UPF advertises that IP address block toward the Internet, ensuring that return traffic is routed to the right UPF.

5. User-Plane Modes

This section introduces an SRv6-based mobile user plane. It presents two different "modes" that vary with respect to the use of SRv6.

The first mode is the "Traditional mode", which inherits the current 3GPP mobile architecture. In this mode, the [GTP-U protocol \[TS.29281\]](#) is replaced by SRv6. However, the N3, N9, and N6 interfaces are still point-to-point interfaces with no intermediate waypoints as in the current mobile network architecture.

The second mode is the "Enhanced mode". This is an evolution from the "Traditional mode". In this mode, the N3, N9, or N6 interfaces have intermediate waypoints (SIDs) that are used for traffic engineering or VNF purposes transparent to 3GPP functionalities. This results in optimal end-to-end policies across the mobile network with transport and services awareness.

In both the Traditional and the Enhanced modes, this document assumes that the gNB as well as the UPFs are SR-aware (N3, N9, and potentially N6 interfaces are SRv6).

In addition to those two modes, this document introduces three mechanisms for interworking with legacy access networks (those where the N3 interface is unmodified). In this document, they are introduced as a variant to the Enhanced mode, but they are equally applicable to the Traditional mode.

One of these mechanisms is designed to interwork with legacy gNBs using GTP-U/IPv4. The second mechanism is designed to interwork with legacy gNBs using GTP-U/IPv6. The third mechanism is another mode that allows deploying SRv6 when legacy gNBs and UPFs still run GTP-U.

This document uses the SRv6 Endpoint Behaviors defined in [RFC8986] as well as the new SRv6 Endpoint Behaviors designed for the mobile user plane that are defined in [Section 6](#) of this document.

5.1. Traditional Mode

In the Traditional mode, the existing mobile UPFs remain unchanged with the sole exception of the use of SRv6 as the data plane instead of GTP-U. There is no impact to the rest of the mobile system.

In existing 3GPP mobile networks, a PDU Session is mapped 1-for-1 with a specific GTP-U tunnel (Tunnel Endpoint Identifier (TEID)). This 1-for-1 mapping is mirrored here to replace GTP-U encapsulation with the SRv6 encapsulation, while not changing anything else. There will be a unique SRv6 SID associated with each PDU Session, and the SID list only contains a single SID.

The Traditional mode minimizes the required changes to the mobile system; hence, it is a good starting point for forming common ground.

The gNB/UPF control plane (N2/N4 interface) is unchanged; specifically, a single IPv6 address is provided to the gNB. The same control plane signaling is used, and the gNB/UPF decides to use SRv6 based on signaled GTP-U parameters per local policy. The only information from the GTP-U parameters used for the SRv6 policy is the TEID, QFI (QoS Flow Identifier), and the IPv6 Destination Address.

Our example topology is shown in [Figure 2](#). The gNB and the UPFs are SR-aware. In the descriptions of the uplink and downlink packet flow, A is an IPv6 address of the UE, and Z is an IPv6 address reachable within the DN. End.MAP, a new SRv6 Endpoint Behavior defined in [Section 6.2](#), is used.

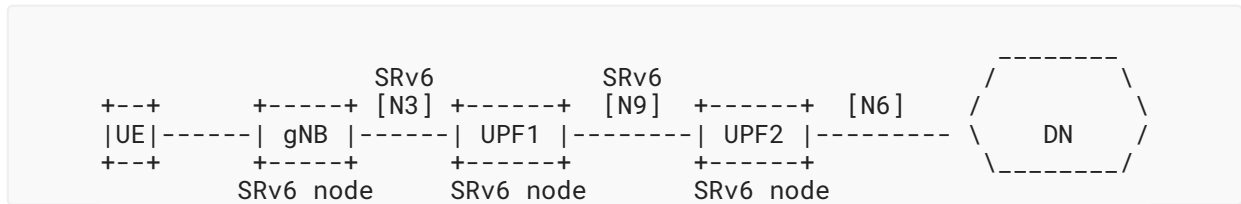

Figure 2: Traditional Mode - Example Topology

5.1.1. Packet Flow - Uplink

The uplink packet flow is as follows:

```

UE_out   : (A, Z)
gNB_out  : (gNB, U1::1) (A, Z)    -> H.Encaps.Red <U1::1>
UPF1_out : (gNB, U2::1) (A, Z)    -> End.MAP
UPF2_out : (A, Z)                 -> End.DT4 or End.DT6

```

When the UE packet arrives at the gNB, the gNB performs an H.Encaps.Red operation. Since there is only one SID, there is no need to push an SRH (reduced SRH). gNB only adds an outer IPv6 header with IPv6 DA U1::1. gNB obtains the SID U1::1 from the existing control plane (N2 interface). U1::1 represents an anchoring SID specific for that session at UPF1.

When the packet arrives at UPF1, the SID U1::1 is associated with the End.MAP SRv6 Endpoint Behavior. End.MAP replaces U1::1 with U2::1, which belongs to the next UPF (U2).

When the packet arrives at UPF2, the SID U2::1 corresponds to an End.DT4/End.DT6/End.DT46 SRv6 Endpoint Behavior. UPF2 decapsulates the packet, performs a lookup in a specific table associated with that mobile network, and forwards the packet toward the DN.

5.1.2. Packet Flow - Downlink

The downlink packet flow is as follows:

```

UPF2_in  : (Z, A)
UPF2_out : (U2::, U1::2) (Z, A)    -> H.Encaps.Red <U1::2>
UPF1_out : (U2::, gNB::1) (Z, A)   -> End.MAP
gNB_out  : (Z, A)                  -> End.DX4, End.DX6, End.DX2

```

When the packet arrives at the UPF2, the UPF2 maps that flow into a PDU Session. This PDU Session is associated with the segment endpoint <U1::2>. UPF2 performs an H.Encaps.Red operation, encapsulating the packet into a new IPv6 header with no SRH since there is only one SID.

Upon packet arrival on UPF1, the SID U1::2 is a local SID associated with the End.MAP SRv6 Endpoint Behavior. It maps the SID to the next anchoring point and replaces U1::2 with gNB::1, which belongs to the next hop.

Upon packet arrival on gNB, the SID gNB::1 corresponds to an End.DX4, End.DX6, or End.DX2 behavior (depending on the PDU Session Type). The gNB decapsulates the packet, removing the IPv6 header and all its extensions headers, and forwards the traffic toward the UE.

5.2. Enhanced Mode

Enhanced mode improves scalability, provides traffic engineering capabilities, and allows service programming [SR-SERV-PROG], thanks to the use of multiple SIDs in the SID list (instead of a direct connectivity in between UPFs with no intermediate waypoints as in Traditional mode).

Thus, the main difference is that the SR Policy **MAY** include SIDs for traffic engineering and service programming in addition to the anchoring SIDs at UPFs.

Additionally, in this mode, the operator may choose to aggregate several devices under the same SID list (e.g., stationary residential meters (water and energy) connected to the same cell) to improve scalability.

The gNB/UPF control plane (N2/N4 interface) is unchanged; specifically, a single IPv6 address is provided to the gNB. A local policy instructs the gNB to use SRv6.

The gNB resolves the IP address received via the control plane into a SID list. The resolution mechanism is out of the scope of this document.

Note that the SIDs **MAY** use the argument [Args.Mob.Session \(Section 6.1\)](#) if required by the UPFs.

Figure 3 shows an Enhanced mode topology. The gNB and the UPF are SR-aware. The figure shows two service segments, S1 and C1. S1 represents a VNF in the network, and C1 represents an intermediate router used for traffic engineering purposes to enforce a low-latency path in the network. Note that neither S1 nor C1 are required to have an N4 interface.

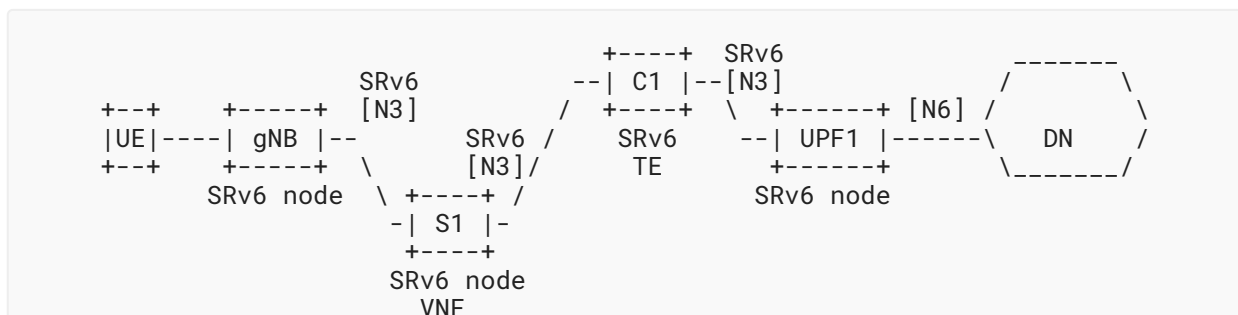

Figure 3: Enhanced Mode - Example Topology

5.2.1. Packet Flow - Uplink

The uplink packet flow is as follows:

```

UE_out   : (A, Z)
gNB_out  : (gNB, S1)(U1::1, C1; SL=2)(A, Z)->H.Encaps.Red<S1, C1, U1::1>
S1_out   : (gNB, C1)(U1::1, C1; SL=1)(A, Z)
C1_out   : (gNB, U1::1)(A, Z)                ->End with PSP
UPF1_out : (A, Z)                            ->End.DT4, End.DT6, End.DT2U
    
```

UE sends its packet (A,Z) on a specific bearer to its gNB. gNB's control plane associates that session from the UE(A) with the IPv6 address B. gNB resolves B into a SID list <S1, C1, U1::1>.

When gNB transmits the packet, it contains all the segments of the SR Policy. The SR Policy includes segments for traffic engineering (C1) and for service programming (S1).

Nodes S1 and C1 perform their related Endpoint functionality and forward the packet. The "End with PSP" functionality refers to the Endpoint Behavior with Penultimate Segment Popping as defined in [RFC8986].

When the packet arrives at UPF1, the active segment (U1::1) is an End.DT4/End.DT6/End.DT2U, which performs the decapsulation (removing the IPv6 header with all its extension headers) and forwards toward the DN.

5.2.2. Packet Flow - Downlink

The downlink packet flow is as follows:

```

UPF1_in : (Z,A)                                ->UPF1 maps the flow w/
                                                SID list <C1,S1, gNB>
UPF1_out : (U1::1, C1)(gNB::1, S1; SL=2)(Z,A) ->H.Encaps.Red
C1_out   : (U1::1, S1)(gNB::1, S1; SL=1)(Z,A)
S1_out   : (U1::1, gNB::1)(Z,A)                ->End with PSP
gNB_out  : (Z,A)                                ->End.DX4/End.DX6/End.DX2

```

When the packet arrives at the UPF1, the UPF1 maps that particular flow into a UE PDU Session. This UE PDU Session is associated with the policy <C1, S1, gNB>. The UPF1 performs a H.Encaps.Red operation, encapsulating the packet into a new IPv6 header with its corresponding SRH.

The nodes C1 and S1 perform their related Endpoint processing.

Once the packet arrives at the gNB, the IPv6 DA corresponds to an End.DX4, End.DX6, or End.DX2 behavior at the gNB (depending on the underlying traffic). The gNB decapsulates the packet, removing the IPv6 header, and forwards the traffic towards the UE. The SID gNB::1 is one example of a SID associated to this service.

Note that there are several means to provide the UE session aggregation. The decision about which one to use is a local decision made by the operator. One option is to use [Args.Mob.Session \(Section 6.1\)](#). Another option comprises the gNB performing an IP lookup on the inner packet by using the End.DT4, End.DT6, and End.DT2U behaviors.

5.2.3. Scalability

The Enhanced mode improves scalability since it allows the aggregation of several UEs under the same SID list. For example, in the case of stationary residential meters that are connected to the same cell, all such devices can share the same SID list. This improves scalability compared to Traditional mode (unique SID per UE) and compared to GTP-U (TEID per UE).

5.3. Enhanced Mode with Unchanged gNB GTP-U Behavior

This section describes two mechanisms for interworking with legacy gNBs that still use GTP-U: one for IPv4 and another for IPv6.

In the interworking scenarios illustrated in [Figure 4](#), the gNB does not support SRv6. The gNB supports GTP-U encapsulation over IPv4 or IPv6. To achieve interworking, an SR Gateway (SRGW) entity is added. The SRGW is a new entity that maps the GTP-U traffic into SRv6. It is deployed at the boundary of the SR domain and performs the mapping functionality for inbound and outbound traffic.

The SRGW is not an anchor point and maintains very little state. For this reason, both IPv4 and IPv6 methods scale to millions of UEs.

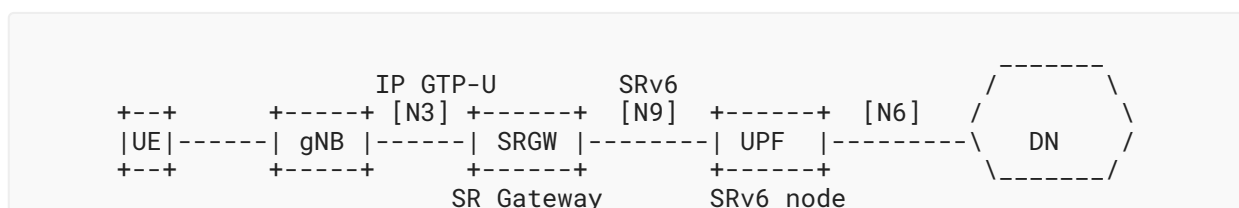

Figure 4: Example Topology for Interworking

Both of the mechanisms described in this section are applicable to the Traditional mode and the Enhanced mode.

5.3.1. Interworking with IPv6 GTP-U

In this interworking mode, the gNB at the N3 interface uses GTP-U over IPv6.

Key points:

- The gNB is unchanged (control plane or user plane) and encapsulates into GTP-U (N3 interface is not modified).
- The 5G control plane towards the gNB (N2 interface) is unmodified, though multiple UPF addresses need to be used. One IPv6 address (i.e., a BSID at the SRGW) is needed per <SLA, PDU Session Type>. The SRv6 SID is different depending on the required <SLA, PDU Session Type> combination.
- In the uplink, the SRGW removes the GTP-U header, finds the SID list related to the IPv6 DA, and adds SRH with the SID list.
- There is no state for the downlink at the SRGW.
- There is simple state in the uplink at the SRGW; using Enhanced mode results in fewer SR Policies on this node. An SR Policy is shared across UEs as long as they belong to the same context (i.e., tenant). A set of many different policies (i.e., different SLAs) increases the amount of state required.
- When a packet from the UE leaves the gNB, it is SR-routed. This simplifies network slicing [[RFC9350](#)].

- In the uplink, the SRv6 BSID steers traffic into an SR Policy when it arrives at the SRGW.

An example topology is shown in [Figure 5](#).

S1 and C1 are two service segments. S1 represents a VNF in the network, and C1 represents a router configured for traffic engineering.

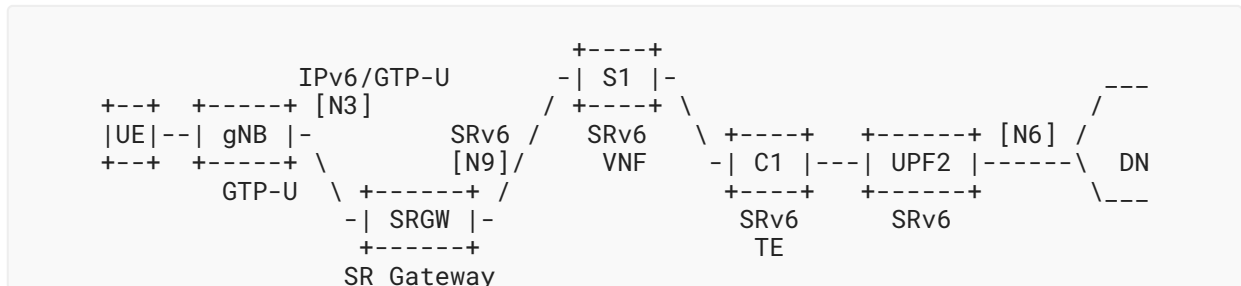

Figure 5: Enhanced Mode with Unchanged gNB IPv6/GTP-U Behavior

5.3.1.1. Packet Flow - Uplink

The uplink packet flow is as follows:

```

UE_out   : (A, Z)
gNB_out  : (gNB, B)(GTP: TEID T)(A, Z)    -> Interface N3 unmodified
                                               (IPv6/GTP)
SRGW_out : (SRGW, S1)(U2::T, C1; SL=2)(A, Z) -> B is an End.M.GTP6.D
                                               SID at the SRGW
S1_out   : (SRGW, C1)(U2::T, C1; SL=1)(A, Z)
C1_out   : (SRGW, U2::T)(A, Z)            -> End with PSP
UPF2_out : (A, Z)                         -> End.DT4 or End.DT6

```

The UE sends a packet destined to Z toward the gNB on a specific bearer for that session. The gNB, which is unmodified, encapsulates the packet into IPv6, UDP, and GTP-U headers. The IPv6 DA B and the GTP-U TEID T are the ones received in the N2 interface.

The IPv6 address that was signaled over the N2 interface for that UE PDU Session, B, is now the IPv6 DA. B is an SRv6 Binding SID at the SRGW. Hence, the packet is routed to the SRGW.

When the packet arrives at the SRGW, the SRGW identifies B as an End.M.GTP6.D Binding SID (see [Section 6.3](#)). Hence, the SRGW removes the IPv6, UDP, and GTP-U headers and pushes an IPv6 header with its own SRH containing the SIDs bound to the SR Policy associated with this Binding SID. There is at least one instance of the End.M.GTP6.D SID per PDU type.

S1 and C1 perform their related Endpoint functionality and forward the packet.

When the packet arrives at UPF2, the active segment is (U2::T), which is bound to End.DT4/6. UPF2 then decapsulates (removing the outer IPv6 header with all its extension headers) and forwards the packet toward the DN.

5.3.1.2. Packet Flow - Downlink

The downlink packet flow is as follows:

```

UPF2_in : (Z,A)                                -> UPF2 maps the flow with
                                                <C1, S1, SRGW::TEID,gNB>
UPF2_out: (U2::1, C1)(gNB, SRGW::TEID, S1; SL=3)(Z,A) -> H.Encaps.Red
C1_out  : (U2::1, S1)(gNB, SRGW::TEID, S1; SL=2)(Z,A)
S1_out  : (U2::1, SRGW::TEID)(gNB, SRGW::TEID, S1, SL=1)(Z,A)
SRGW_out: (SRGW, gNB)(GTP: TEID=T)(Z,A)  -> SRGW/96 is End.M.GTP6.E
gNB_out : (Z,A)

```

When a packet destined to A arrives at the UPF2, the UPF2 performs a lookup in the table associated to A and finds the SID list <C1, S1, SRGW::TEID, gNB>. The UPF2 performs an H.Encaps.Red operation, encapsulating the packet into a new IPv6 header with its corresponding SRH.

C1 and S1 perform their related Endpoint processing.

Once the packet arrives at the SRGW, the SRGW identifies the active SID as an End.M.GTP6.E function. The SRGW removes the IPv6 header and all its extensions headers. The SRGW generates new IPv6, UDP, and GTP-U headers. The new IPv6 DA is the gNB, which is the last SID in the received SRH. The TEID in the generated GTP-U header is also an argument of the received End.M.GTP6.E SID. The SRGW pushes the headers to the packet and forwards the packet toward the gNB. There is one instance of the End.M.GTP6.E SID per PDU type.

Once the packet arrives at the gNB, the packet is a regular IPv6/GTP-U packet. The gNB looks for the specific radio bearer for that TEID and forwards it on the bearer. This gNB behavior is not modified from current and previous generations.

5.3.1.3. Scalability

For downlink traffic, the SRGW is stateless. All the state is in the SRH pushed by the UPF2. The UPF2 must have the UE state since it is the UE's session anchor point.

For uplink traffic, the state at the SRGW does not necessarily need to be unique per PDU Session; the SR Policy can be shared among UEs. This enables more scalable SRGW deployments compared to a solution holding millions of states, one or more per UE.

5.3.2. Interworking with IPv4 GTP-U

In this interworking mode, the gNB uses GTP over IPv4 in the N3 interface.

Key points:

- The gNB is unchanged and encapsulates packets into GTP-U (the N3 interface is not modified).
- N2 signaling is not changed, though multiple UPF addresses need to be provided -- one for each PDU Session Type.
- In the uplink, traffic is classified by SRGW's classification engine and steered into an SR Policy. The SRGW may be implemented in a UPF or as a separate entity. How the

classification engine rules are set up is outside the scope of this document, though one example is using BGP signaling from a Mobile User Plane (MUP) Controller [MUP-SR-ARCH].

- SRGW removes the GTP-U header, finds the SID list related to DA, and adds an SRH with the SID list.

An example topology is shown in Figure 6. In this mode, the gNB is an unmodified gNB using IPv4/GTP. The UPFs are SR-aware. As before, the SRGW maps the IPv4/GTP-U traffic to SRv6.

S1 and C1 are two service segment endpoints. S1 represents a VNF in the network, and C1 represents a router configured for traffic engineering.

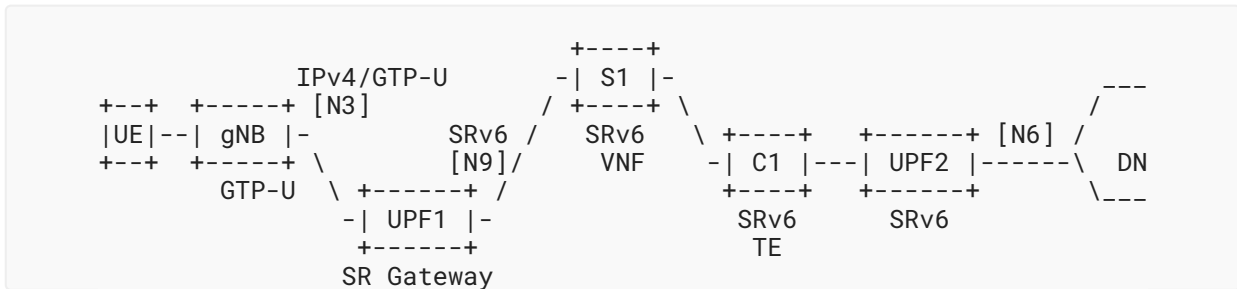
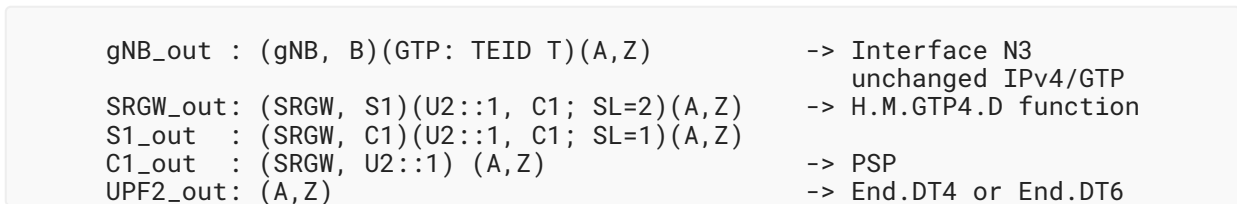

Figure 6: Enhanced Mode with Unchanged gNB IPv4/GTP-U Behavior

5.3.2.1. Packet Flow - Uplink

The uplink packet flow is as follows:



The UE sends a packet destined to Z toward the gNB on a specific bearer for that session. The gNB, which is unmodified, encapsulates the packet into a new IPv4, UDP, and GTP-U headers. The IPv4 DA, B, and the GTP-U TEID are the ones received at the N2 interface.

When the packet arrives at the SRGW for UPF1, the SRGW has a classification engine rule for incoming traffic from the gNB that steers the traffic into an SR Policy by using the function H.M.GTP4.D. The SRGW removes the IPv4, UDP, and GTP headers and pushes an IPv6 header with its own SRH containing the SIDs related to the SR Policy associated with this traffic. The SRGW forwards according to the new IPv6 DA.

S1 and C1 perform their related Endpoint functionality and forward the packet.

When the packet arrives at UPF2, the active segment is (U2::1), which is bound to End.DT4/6, which performs the decapsulation (removing the outer IPv6 header with all its extension headers) and forwards toward the DN.

Note that the interworking mechanisms for IPv4/GTP-U and IPv6/GTP-U differ. This is due to the fact that IPv6/GTP-U can leverage the remote steering capabilities provided by the Segment Routing BSID. In IPv4, this construct is not available, and building a similar mechanism would require a significant address consumption.

5.3.2.2. Packet Flow - Downlink

The downlink packet flow is as follows:

UPF2_in : (Z, A)	-> UPF2 maps flow with SID <C1, S1, GW::SA:DA:TEID>
UPF2_out : (U2::1, C1)(GW::SA:DA:TEID, S1; SL=2)(Z, A)	->H.Encaps.Red
C1_out : (U2::1, S1)(GW::SA:DA:TEID, S1; SL=1)(Z, A)	
S1_out : (U2::1, GW::SA:DA:TEID)(Z, A)	
SRGW_out : (GW, gNB)(GTP: TEID=T)(Z, A)	-> End.M.GTP4.E
gNB_out : (Z, A)	

When a packet destined to A arrives at the UPF2, the UPF2 performs a lookup in the table associated to A and finds the SID list <C1, S1, SRGW::SA:DA:TEID>. The UPF2 performs an H.Encaps.Red operation, encapsulating the packet into a new IPv6 header with its corresponding SRH.

The nodes C1 and S1 perform their related Endpoint processing.

Once the packet arrives at the SRGW, the SRGW identifies the active SID as an End.M.GTP4.E function. The SRGW removes the IPv6 header and all its extensions headers. The SRGW generates IPv4, UDP, and GTP-U headers. The IPv4 SA and DA are received as SID arguments. The TEID in the generated GTP-U header is the argument of the received End.M.GTP4.E SID. The SRGW pushes the headers to the packet and forwards the packet toward the gNB.

When the packet arrives at the gNB, the packet is a regular IPv4/GTP-U packet. The gNB looks for the specific radio bearer for that TEID and forwards it on the bearer. This gNB behavior is not modified from current and previous generations.

5.3.2.3. Scalability

For downlink traffic, the SRGW is stateless. All the state is in the SRH pushed by the UPF2. The UPF must have this UE-base state anyway (since it is its anchor point).

For uplink traffic, the state at the SRGW is dedicated on a per-UE/session basis according to a classification engine. There is state for steering the different sessions in the form of an SR Policy. However, SR Policies are shared among several UE/sessions.

5.3.3. Extensions to the Interworking Mechanisms

This section presents two mechanisms for interworking with gNBs and UPFs that do not support SRv6. These mechanisms are used to support GTP-U over IPv4 and IPv6.

Even though these methods are presented as an extension to the Enhanced mode, they are also applicable to the Traditional mode.

5.4. SRv6 Drop-In Interworking

This section introduces another mode useful for legacy gNB and UPFs that still operate with GTP-U. This mode provides an SRv6-enabled user plane in between two GTP-U tunnel endpoints.

This mode employs two SRGWs that map GTP-U traffic to SRv6 and vice versa.

Unlike other interworking modes, in this mode, both of the mobility overlay endpoints use GTP-U. Two SRGWs are deployed in either an N3 or N9 interface to realize an intermediate SR Policy.

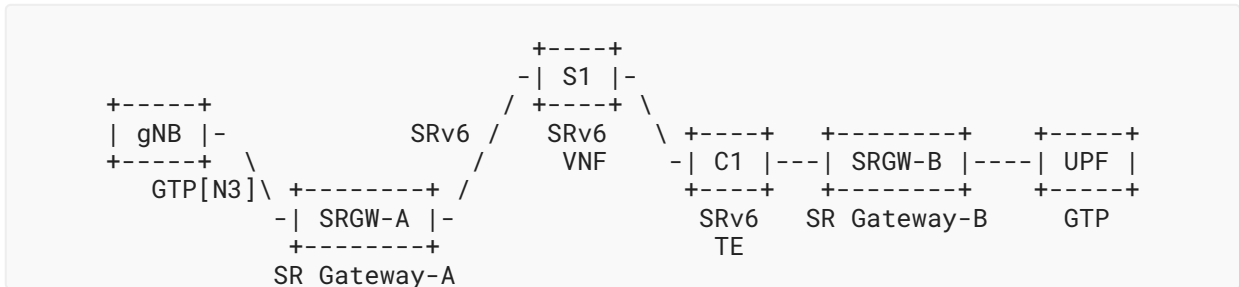

Figure 7: Example Topology for SRv6 Drop-In Mode

The packet flow of Figure 7 is as follows:

```

gNB_out : (gNB, U::1)(GTP: TEID T)(A,Z)
GW-A_out: (GW-A, S1)(U::1, SGB::TEID, C1; SL=3)(A,Z)->U::1 is an
                                                End.M.GTP6.D.Di
                                                SID at SRGW-A

S1_out   : (GW-A, C1)(U::1, SGB::TEID, C1; SL=2)(A,Z)
C1_out   : (GW-A, SGB::TEID)(U::1, SGB::TEID, C1; SL=1)(A,Z)
GW-B_out: (GW-B, U::1)(GTP: TEID T)(A,Z)      ->SGB::TEID is an
                                                End.M.GTP6.E
                                                SID at SRGW-B

UPF_out  : (A,Z)
    
```

When a packet destined to Z is sent to the gNB, which is unmodified (control plane and user plane remain GTP-U), gNB performs encapsulation into new IP, UDP, and GTP-U headers. The IPv6 DA, U::1, and GTP-U TEID are the ones received at the N2 interface.

The IPv6 address that was signaled over the N2 interface for that PDU Session, U::1, is now the IPv6 DA. U::1 is an SRv6 Binding SID at SRGW-A. Hence, the packet is routed to the SRGW.

When the packet arrives at SRGW-A, the SRGW identifies U::1 as an End.M.GTP6.D.Di Binding SID (see Section 6.4). Hence, the SRGW removes the IPv6, UDP, and GTP-U headers and pushes an IPv6 header with its own SRH containing the SIDs bound to the SR Policy associated with this Binding SID. There is one instance of the End.M.GTP6.D.Di SID per PDU type.

S1 and C1 perform their related Endpoint functionality and forward the packet.

Once the packet arrives at SRGW-B, the SRGW identifies the active SID as an End.M.GTP6.E function. The SRGW removes the IPv6 header and all its extensions headers. The SRGW generates new IPv6, UDP, and GTP headers. The new IPv6 DA is U::1, which is the last SID in the received SRH. The TEID in the generated GTP-U header is an argument of the received End.M.GTP6.E SID. The SRGW pushes the headers to the packet and forwards the packet toward UPF. There is one instance of the End.M.GTP6.E SID per PDU type.

Once the packet arrives at UPF, the packet is a regular IPv6/GTP packet. The UPF looks for the specific rule for that TEID to forward the packet. This UPF behavior is not modified from current and previous generations.

6. SRv6 Segment Endpoint Mobility Behaviors

This section introduces new SRv6 Endpoint Behaviors for the mobile user plane. The behaviors described in this document are compatible with the NEXT and REPLACE flavors defined in [SRV6-SRH-COMPRESSION].

6.1. Args.Mob.Session

Args.Mob.Session provides per-session information for charging, buffering, or other purposes required by some mobile nodes. The Args.Mob.Session argument format is used in combination with the End.Map, End.DT4/End.DT6/End.DT46, and End.DX4/End.DX6/End.DX2 behaviors. Note that proposed format is applicable for 5G networks, while similar formats could be used for legacy networks.

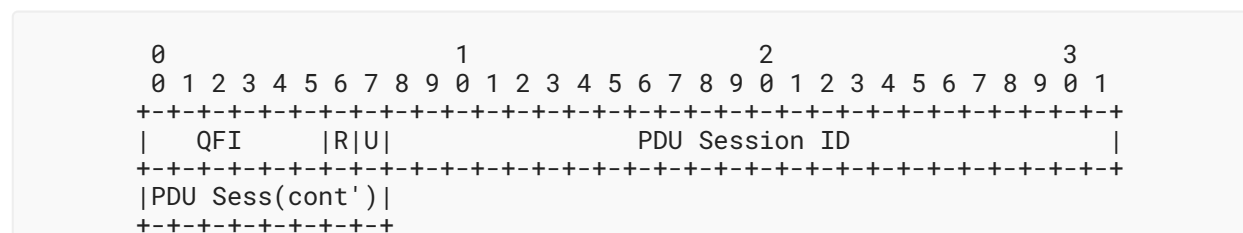

Figure 8: Args.Mob.Session Format

QFI: QoS Flow Identifier [TS.38415].

R: Reflective QoS Indication [TS.23501]. This parameter indicates the activation of reflective QoS towards the UE for the transferred packet. Reflective QoS enables the UE to map uplink user-plane traffic to QoS flows without SMF-provided QoS rules.

U: Unused and for future use. **MUST** be 0 on transmission and ignored on receipt.

PDU Session ID: Identifier of PDU Session. The GTP-U equivalent is TEID.

Args.Mob.Session is required in case one SID aggregates multiple PDU Sessions. Since the SRv6 SID is likely NOT to be instantiated per PDU Session, Args.Mob.Session helps the UPF to perform the behaviors that require granularity per QFI and/or per PDU Session.

Note that the encoding of user-plane messages (e.g., Echo Request, Echo Reply, Error Indication, and End Marker) is out of the scope of this document. [SRV6-UP-MSG-ENCODING] defines one possible encoding method.

6.2. End.MAP

End.MAP (Endpoint Behavior with SID mapping) is used in several scenarios. Particularly in mobility, End.MAP is used by the intermediate UPFs.

When node N receives a packet whose IPv6 DA is D and D is a local End.MAP SID, N does the following:

```
S01. If (IPv6 Hop Limit <= 1) {
S02.   Send an ICMP Time Exceeded message to the Source Address with
       Code 0 (Hop limit exceeded in transit),
       interrupt packet processing, and discard the packet.
S03. }
S04. Decrement IPv6 Hop Limit by 1
S05. Update the IPv6 DA with the new mapped SID
S06. Submit the packet to the egress IPv6 FIB lookup for
       transmission to the new destination
```

Note: The SRH is not modified (neither the SID nor the SL value).

6.3. End.M.GTP6.D

End.M.GTP6.D (Endpoint Behavior with IPv6/GTP-U decapsulation into SR Policy) is used in the interworking scenario for the uplink towards SRGW from the legacy gNB using IPv6/GTP. Any SID instance of this behavior is associated with an SR Policy B and an IPv6 Source Address S.

When the SR Gateway node N receives a packet destined to D, and D is a local End.M.GTP6.D SID, N does the following:

```
S01. When an SRH is processed {
S02.   If (Segments Left != 0) {
S03.     Send an ICMP Parameter Problem to the Source Address with
         Code 0 (Erroneous header field encountered) and
         Pointer set to the Segments Left field,
         interrupt packet processing, and discard the packet.
S04.   }
S05.   Proceed to process the next header in the packet
S06. }
```

When processing the Upper-Layer header of a packet matching a FIB entry locally instantiated as an End.M.GTP6.D SID, N does the following:

```

S01. If (Next Header (NH) == UDP & UDP_Dest_port == GTP) {
S02.   Copy the GTP-U TEID and QFI to buffer memory
S03.   Pop the IPv6, UDP, and GTP-U headers
S04.   Push a new IPv6 header with its own SRH containing B
S05.   Set the outer IPv6 SA to S
S06.   Set the outer IPv6 DA to the first SID of B
S07.   Set the outer Payload Length, Traffic Class, Flow Label,
       Hop Limit, and Next Header (NH) fields
S08.   Write in the SRH[0] the Args.Mob.Session based on
       the information in buffer memory
S09.   Submit the packet to the egress IPv6 FIB lookup for
       transmission to the new destination
S10. } Else {
S11.   Process as per [RFC8986], Section 4.1.1
S12. }

```

Notes:

- In line S07, the NH is set based on the SID parameter. There is one instantiation of the End.M.GTP6.D SID per PDU Session Type; hence, the NH is already known in advance. In addition, for the IPv4v6 PDU Session Type, the router inspects the first nibble of the PDU to know the NH value.
- The last segment **SHOULD** be followed by an Args.Mob.Session argument space, which is used to provide the session identifiers, as shown in line S08.

6.4. End.M.GTP6.D.Di

End.M.GTP6.D.Di (Endpoint Behavior with IPv6/GTP-U decapsulation into SR Policy for Drop-in Mode) is used in the SRv6 drop-in interworking scenario described in [Section 5.4](#). The difference between End.M.GTP6.D as another variant of the IPv6/GTP decapsulation function is that the original IPv6 DA of the GTP-U packet is preserved as the last SID in SRH.

Any SID instance of this behavior is associated with an SR Policy B and an IPv6 Source Address S.

When the SR Gateway node N receives a packet destined to D, and D is a local End.M.GTP6.D.Di SID, N does the following:

```

S01. When an SRH is processed {
S02.   If (Segments Left != 0) {
S03.     Send an ICMP Parameter Problem to the Source Address with
           Code 0 (Erroneous header field encountered) and
           Pointer set to the Segments Left field,
           interrupt packet processing, and discard the packet.
S04.   }
S05.   Proceed to process the next header in the packet
S06. }

```

When processing the Upper-Layer header of a packet matching a FIB entry locally instantiated as an End.M.GTP6.Di SID, N does the following:

```

S01. If (Next Header = UDP & UDP_Dest_port = GTP) {
S02.   Copy D to buffer memory
S03.   Pop the IPv6, UDP, and GTP-U headers
S04.   Push a new IPv6 header with its own SRH containing B
S05.   Set the outer IPv6 SA to S
S06.   Set the outer IPv6 DA to the first SID of B
S07.   Set the outer Payload Length, Traffic Class, Flow Label,
       Hop Limit, and Next Header fields
S08.   Prepend D to the SRH (as SRH[0]) and set SL accordingly
S09.   Submit the packet to the egress IPv6 FIB lookup for
       transmission to the new destination
S10. } Else {
S11.   Process as per [RFC8986], Section 4.1.1
S12. }

```

Notes:

- In line S07, the NH is set based on the SID parameter. There is one instantiation of the End.M.GTP6.Di SID per PDU Session Type; hence, the NH is already known in advance. In addition, for the IPv4v6 PDU Session Type, the router inspects the first nibble of the PDU to know the NH value.
- S **SHOULD** be an End.M.GTP6.E SID instantiated at the SR Gateway.

6.5. End.M.GTP6.E

End.M.GTP6.E (Endpoint Behavior with encapsulation for IPv6/GTP-U tunnel" behavior) is used among others in the interworking scenario for the downlink toward the legacy gNB using IPv6/GTP.

The prefix of End.M.GTP6.E SID **MUST** be followed by the Args.Mob.Session argument space, which is used to provide the session identifiers.

When the SR Gateway node N receives a packet destined to D, and D is a local End.M.GTP6.E SID, N does the following:

```

S01. When an SRH is processed {
S02.   If (Segments Left != 1) {
S03.     Send an ICMP Parameter Problem to the Source Address with
       Code 0 (Erroneous header field encountered) and
       Pointer set to the Segments Left field,
       interrupt packet processing, and discard the packet.
S04.   }
S05.   Proceed to process the next header in the packet
S06. }

```

When processing the Upper-Layer header of a packet matching a FIB entry locally instantiated as an End.M.GTP6.E SID, N does the following:

```

S01. Copy SRH[0] and D to buffer memory
S02. Pop the IPv6 header and all its extension headers
S03. Push a new IPv6 header with a UDP/GTP-U header
S04. Set the outer IPv6 SA to S
S05. Set the outer IPv6 DA from buffer memory
S06. Set the outer Payload Length, Traffic Class, Flow Label,
     Hop Limit, and Next Header fields
S07. Set the GTP-U TEID (from buffer memory)
S08. Submit the packet to the egress IPv6 FIB lookup for
     transmission to the new destination

```

Notes:

- An End.M.GTP6.E SID **MUST** always be the penultimate SID. The TEID is extracted from the argument space of the current SID.
- The source address S **SHOULD** be an End.M.GTP6.D SID instantiated at the egress SR Gateway.

6.6. End.M.GTP4.E

End.M.GTP4.E (Endpoint Behavior with encapsulation for IPv4/GTP-U tunnel) is used in the downlink when doing interworking with legacy gNB using IPv4/GTP.

When the SR Gateway node N receives a packet destined to S, and S is a local End.M.GTP4.E SID, N does the following:

```

S01. When an SRH is processed {
S02.   If (Segments Left != 0) {
S03.     Send an ICMP Parameter Problem to the Source Address with
         Code 0 (Erroneous header field encountered) and
         Pointer set to the Segments Left field,
         interrupt packet processing, and discard the packet.
S04.   }
S05.   Proceed to process the next header in the packet
S06. }

```

When processing the Upper-Layer header of a packet matching a FIB entry locally instantiated as an End.M.GTP4.E SID, N does the following:

```

S01. Store the IPv6 DA and SA in buffer memory
S02. Pop the IPv6 header and all its extension headers
S03. Push a new IPv4 header with a UDP/GTP-U header
S04. Set the outer IPv4 SA and DA (from buffer memory)
S05. Set the outer Total Length, DSCP, Time To Live, and
     Next Header fields
S06. Set the GTP-U TEID (from buffer memory)
S07. Submit the packet to the egress IPv4 FIB lookup for
     transmission to the new destination

```

Notes:

- The End.M.GTP4.E SID in S has the following format:

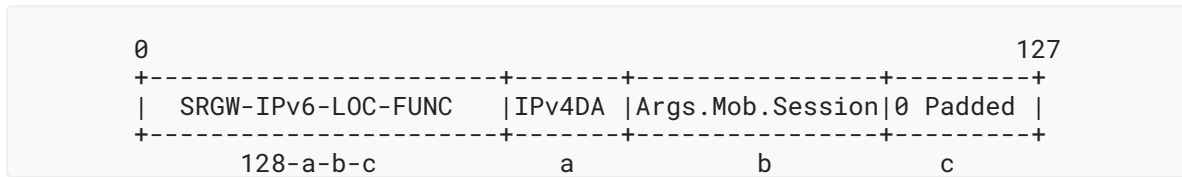

Figure 9: End.M.GTP4.E SID Encoding

- The IPv6 Source Address has the following format:

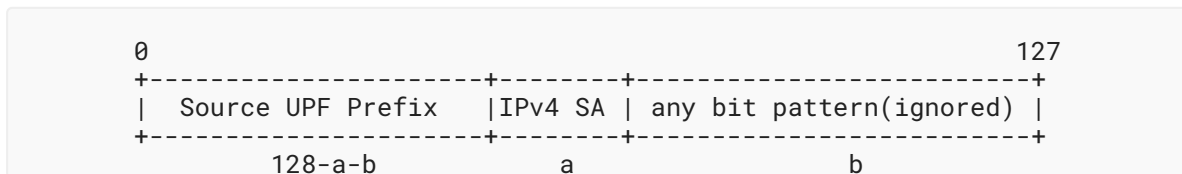

Figure 10: IPv6 SA Encoding for End.M.GTP4.E

6.7. H.M.GTP4.D

H.M.GTP4.D (SR Policy Headend with tunnel decapsulation and map to an SRv6 policy) is used in the direction from the legacy IPv4 user plane to the SRv6 user-plane network.

When the SR Gateway node N receives a packet destined to a SRGW-IPv4-Prefix, N does the following:

```

S01. IF Payload == UDP/GTP-U THEN
S02.   Pop the outer IPv4 header and UDP/GTP-U headers
S03.   Copy IPv4 DA and TEID to form SID B
S04.   Copy IPv4 SA to form IPv6 SA B'
S05.   Encapsulate the packet into a new IPv6 header
S06.   Set the IPv6 DA = B
S07.   Forward along the shortest path to B
S08. ELSE
S09.   Drop the packet
    
```

The SID B has the following format:

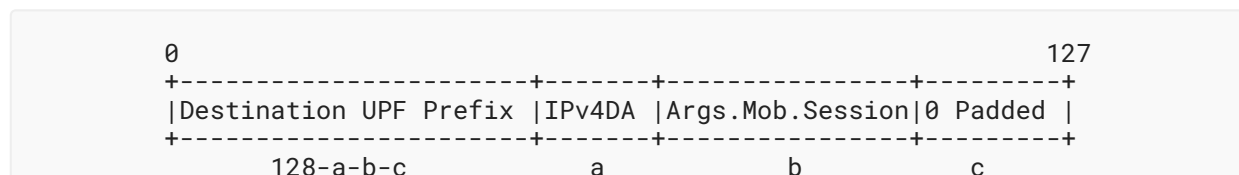

Figure 11: H.M.GTP4.D SID Encoding

The SID B **MAY** be an SRv6 Binding SID instantiated at the first UPF (U1) to bind an SR Policy [RFC9256].

6.8. End.Limit

The mobile user plane requires a rate-limit feature. For this purpose, this document defines a new behavior, called "End.Limit". The "End.Limit" behavior encodes in its arguments the rate-limiting parameter that should be applied to this packet. Multiple flows of packets should have the same group identifier in the SID when those flows are in the same AMBR (Aggregate Maximum Bit Rate) group. The encoding format of the rate-limit segment SID is as follows:

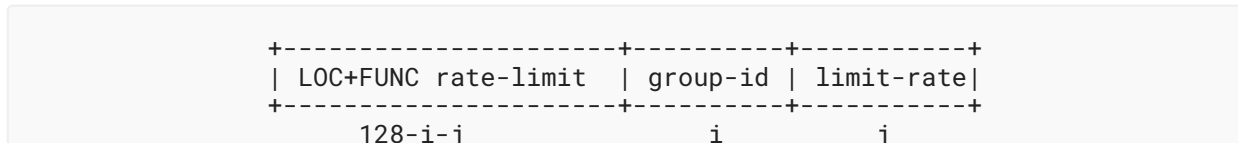

Figure 12: End.Limit: Rate-Limiting Behavior Argument Format

If the limit-rate bits are set to zero, the node should not do rate limiting unless static configuration or control plane sets the limit rate associated to the SID.

7. SRv6-Supported 3GPP PDU Session Types

The 3GPP [TS.23501] defines the following PDU Session Types:

- IPv4
- IPv6
- IPv4v6
- Ethernet
- Unstructured

SRv6 supports the 3GPP PDU Session Types without any protocol overhead by using the corresponding SRv6 behaviors:

- End.DX4 and End.DT4 for IPv4 PDU Sessions
- End.DX6, End.DT6, and End.T for IPv6 PDU Sessions
- End.DT46 for IPv4v6 PDU Sessions
- End.DX2 for L2 and Unstructured PDU Sessions

8. Network Slicing Considerations

A mobile network may be required to implement "network slices", which logically separate network resources within the same SR domain.

[RFC9256] describes a solution to build basic network slices with SR. Depending on the requirements, these slices can be further refined by adopting the mechanisms from:

- IGP Flex-Algo [RFC9350]
- Inter-Domain policies [RFC9087]

Furthermore, these can be combined with ODN/AS (On-Demand Next Hop / Automated Steering) [RFC9256] for automated slice provisioning and traffic steering.

Further details on how these tools can be used to create end-to-end network slices are documented in [NETWORK-SLICE].

9. Control Plane Considerations

This document focuses on user-plane behavior and its independence from the control plane. While the SRv6 mobile user-plane behaviors may be utilized in emerging architectures (for example, those described in [MFA] and [MUP-SR-ARCH]), this document does not impose any change to the existent mobility control plane.

Section 11 allocates SRv6 Endpoint Behavior codepoints for the new behaviors defined in this document.

10. Security Considerations

The security considerations for Segment Routing are discussed in [RFC8402]. More specifically, for SRv6, the security considerations and the mechanisms for securing an SR domain are discussed in [RFC8754]. Together, they describe the required security mechanisms that allow establishment of an SR domain of trust to operate SRv6-based services for internal traffic while preventing any external traffic from accessing or exploiting the SRv6-based services.

The technology described in this document is applied to a mobile network that is within the SR domain. It's important to note the resemblance between the SR domain and the 3GPP Packet Core Domain.

This document introduces new SRv6 Endpoint Behaviors. Those behaviors operate on control plane information, including information within the received SRH payload on which the behaviors operate. Altering the behaviors requires that an attacker alter the SR domain as defined in [RFC8754]. Those behaviors do not need any special security consideration given that they are deployed within that SR domain.

11. IANA Considerations

The following values have been allocated in the "SRv6 Endpoint Behaviors" [RFC8986] subregistry within the top-level "Segment Routing Parameters" registry:

Value	Hex	Endpoint Behavior	Reference	Change Controller
40	0x0028	End.MAP	RFC 9433	IETF
41	0x0029	End.Limit	RFC 9433	IETF
69	0x0045	End.M.GTP6.D	RFC 9433	IETF
70	0x0046	End.M.GTP6.Di	RFC 9433	IETF
71	0x0047	End.M.GTP6.E	RFC 9433	IETF
72	0x0048	End.M.GTP4.E	RFC 9433	IETF

Table 1: SRv6 Mobile User-Plane Endpoint Behavior Types

12. References

12.1. Normative References

- [RFC2119] Bradner, S., "Key words for use in RFCs to Indicate Requirement Levels", BCP 14, RFC 2119, DOI 10.17487/RFC2119, March 1997, <<https://www.rfc-editor.org/info/rfc2119>>.
- [RFC8174] Leiba, B., "Ambiguity of Uppercase vs Lowercase in RFC 2119 Key Words", BCP 14, RFC 8174, DOI 10.17487/RFC8174, May 2017, <<https://www.rfc-editor.org/info/rfc8174>>.
- [RFC8402] Filsfils, C., Ed., Previdi, S., Ed., Ginsberg, L., Decraene, B., Litkowski, S., and R. Shakir, "Segment Routing Architecture", RFC 8402, DOI 10.17487/RFC8402, July 2018, <<https://www.rfc-editor.org/info/rfc8402>>.
- [RFC8754] Filsfils, C., Ed., Dukes, D., Ed., Previdi, S., Leddy, J., Matsushima, S., and D. Voyer, "IPv6 Segment Routing Header (SRH)", RFC 8754, DOI 10.17487/RFC8754, March 2020, <<https://www.rfc-editor.org/info/rfc8754>>.
- [RFC8986] Filsfils, C., Ed., Camarillo, P., Ed., Leddy, J., Voyer, D., Matsushima, S., and Z. Li, "Segment Routing over IPv6 (SRv6) Network Programming", RFC 8986, DOI 10.17487/RFC8986, February 2021, <<https://www.rfc-editor.org/info/rfc8986>>.
- [RFC9256] Filsfils, C., Talaulikar, K., Ed., Voyer, D., Bogdanov, A., and P. Mattes, "Segment Routing Policy Architecture", RFC 9256, DOI 10.17487/RFC9256, July 2022, <<https://www.rfc-editor.org/info/rfc9256>>.
- [TS.23501] 3GPP, "System architecture for the 5G System (5GS)", Version 17.9.0, 3GPP TS 23.501, June 2023.

12.2. Informative References

- [MFA]** Gundavelli, S., Liebsch, M., and S. Matsushima, "Mobility-aware Floating Anchor (MFA)", Work in Progress, Internet-Draft, draft-gundavelli-dmm-mfa-01, 19 September 2018, <<https://datatracker.ietf.org/doc/html/draft-gundavelli-dmm-mfa-01>>.
- [MUP-SR-ARCH]** Matsushima, S., Horiba, K., Khan, A., Kawakami, Y., Murakami, T., Patel, K., Kohno, M., Kamata, T., Camarillo, P., Horn, J., Voyer, D., Zadok, S., Meilik, I., Agrawal, A., and K. Perumal, "Mobile User Plane Architecture using Segment Routing for Distributed Mobility Management", Work in Progress, Internet-Draft, draft-mhkk-dmm-srv6mup-architecture-05, 13 March 2023, <<https://datatracker.ietf.org/doc/html/draft-mhkk-dmm-srv6mup-architecture-05>>.
- [NETWORK-SLICE]** Ali, Z., Filsfils, C., Camarillo, P., Voyer, D., Matsushima, S., Rokui, R., Dhamija, A., and P. Maheshwari, "Building blocks for Network Slice Realization in Segment Routing Network", Work in Progress, Internet-Draft, draft-ali-teas-spring-ns-building-blocks-03, 7 September 2022, <<https://datatracker.ietf.org/doc/html/draft-ali-teas-spring-ns-building-blocks-03>>.
- [RFC9087]** Filsfils, C., Ed., Previdi, S., Dawra, G., Ed., Aries, E., and D. Afanasiev, "Segment Routing Centralized BGP Egress Peer Engineering", RFC 9087, DOI 10.17487/RFC9087, August 2021, <<https://www.rfc-editor.org/info/rfc9087>>.
- [RFC9350]** Psenak, P., Ed., Hegde, S., Filsfils, C., Talaulikar, K., and A. Gulko, "IGP Flexible Algorithm", RFC 9350, DOI 10.17487/RFC9350, February 2023, <<https://www.rfc-editor.org/info/rfc9350>>.
- [SR-SERV-PROG]** Clad, F., Ed., Xu, X., Ed., Filsfils, C., Bernier, D., Li, C., Decraene, B., Ma, S., Yadlapalli, C., Henderickx, W., and S. Salsano, "Service Programming with Segment Routing", Work in Progress, Internet-Draft, draft-ietf-spring-sr-service-programming-07, 15 February 2023, <<https://datatracker.ietf.org/doc/html/draft-ietf-spring-sr-service-programming-07>>.
- [SRV6-DEPLOY-STAT]** Matsushima, S., Filsfils, C., Ali, Z., Li, Z., Rajaraman, K., and A. Dhamija, "SRv6 Implementation and Deployment Status", Work in Progress, Internet-Draft, draft-matsushima-spring-srv6-deployment-status-15, 5 April 2022, <<https://datatracker.ietf.org/doc/html/draft-matsushima-spring-srv6-deployment-status-15>>.
- [SRV6-MOB-ARCH-DISCUSS]** Kohno, M., Clad, F., Camarillo, P., and Z. Ali, "Architecture Discussion on SRv6 Mobile User plane", Work in Progress, Internet-Draft, draft-kohno-dmm-srv6mob-arch-06, 9 March 2023, <<https://datatracker.ietf.org/doc/html/draft-kohno-dmm-srv6mob-arch-06>>.
- [SRV6-MOB-USECASES]** Camarillo, P., Ed., Filsfils, C., Elmalky, H., Ed., Matsushima, S., Voyer, D., Cui, A., and B. Peirens, "SRv6 Mobility Use-Cases", Work in Progress, Internet-Draft, draft-camarilloelmalky-springdmm-srv6-mob-usecases-02, 15 August 2019, <<https://datatracker.ietf.org/doc/html/draft-camarilloelmalky-springdmm-srv6-mob-usecases-02>>.

[SRV6-SRH-COMPRESSION] Cheng, W., Ed., Filsfils, C., Li, Z., Decraene, B., and F. Clad, Ed., "Compressed SRv6 Segment List Encoding in SRH", Work in Progress, Internet-Draft, draft-ietf-spring-srv6-srh-compression-05, 20 June 2023, <<https://datatracker.ietf.org/doc/html/draft-ietf-spring-srv6-srh-compression-05>>.

[SRV6-UP-MSG-ENCODING] Murakami, T., Matsushima, S., Ebisawa, K., Camarillo, P., and R. Shekhar, "User Plane Message Encoding", Work in Progress, Internet-Draft, draft-murakami-dmm-user-plane-message-encoding-05, 5 March 2022, <<https://datatracker.ietf.org/doc/html/draft-murakami-dmm-user-plane-message-encoding-05>>.

[TS.29281] 3GPP, "General Packet Radio System (GPRS) Tunnelling Protocol User Plane (GTPv1-U)", Version 17.4.0, 3GPP TS 29.281, September 2022.

[TS.38415] 3GPP, "PDU session user plane protocol", Version 17.0.0, 3GPP TS 38.415, April 2022.

Acknowledgements

The authors would like to thank Daisuke Yokota, Bart Peirens, Ryokichi Onishi, Kentaro Ebisawa, Peter Bosch, Darren Dukes, Francois Clad, Sri Gundavelli, Sridhar Bhaskaran, Arashmid Akhavain, Ravi Shekhar, Aeneas Dodd-Noble, Carlos Jesus Bernardos, Dirk von Hugo, and Jeffrey Zhang for their useful comments of this work.

Contributors

Kentaro Ebisawa

Toyota Motor Corporation
Japan
Email: ebisawa@toyota-tokyo.tech

Tetsuya Murakami

Arrcus, Inc.
United States of America
Email: tetsuya.ietf@gmail.com

Charles E. Perkins

Lupin Lodge
United States of America
Email: charliep@computer.org

Jakub Horn

Cisco Systems, Inc.
United States of America
Email: jakuhorn@cisco.com

Authors' Addresses

Satoru Matsushima (EDITOR)

SoftBank

Japan

Email: satoru.matsushima@g.softbank.co.jp**Clarence Filsfils**

Cisco Systems, Inc.

Belgium

Email: cf@cisco.com**Miya Kohno**

Cisco Systems, Inc.

Japan

Email: mkohno@cisco.com**Pablo Camarillo Garvia (EDITOR)**

Cisco Systems, Inc.

Spain

Email: pcamaril@cisco.com**Daniel Voyer**

Bell Canada

Canada

Email: daniel.voyer@bell.ca